

Circuit bar mounting

non plug-in cylinder ports in valve	non plug-in cylinder ports in base	non plug-in cylinder ports in base with Pr. Reg.	non plug-in add-on style cylinder ports in base	non plug-in add-a-unit stations	plug-in	plug-in with Pr. Reg.	add-on style plug-in
add-on style plug in with Pr. Reg.	plug-in add-a-unit stations	plug-in add-a-unit stations with Pr. Reg.					

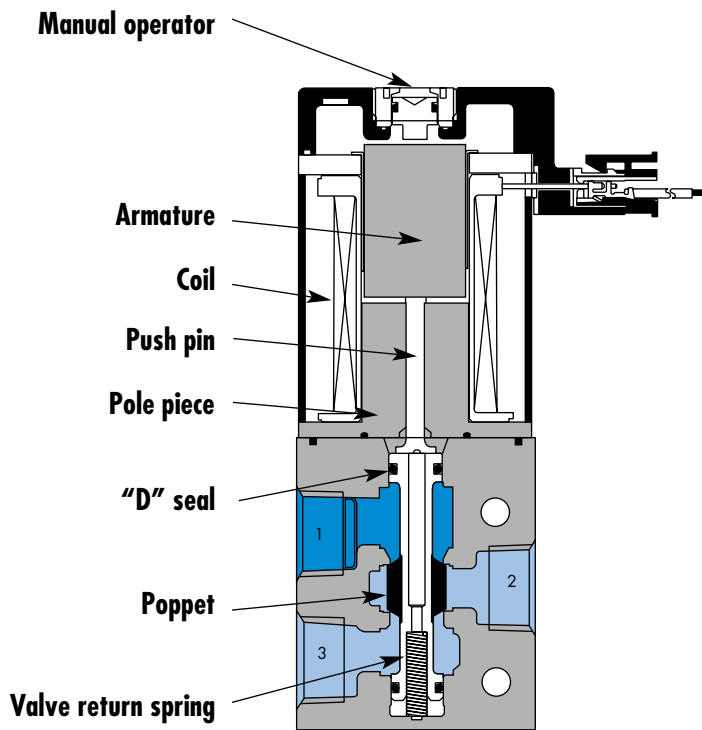

SERIES FEATURES

- Balanced poppet equals consistent high shifting forces.
- Valve shifting forces are consistent and independent of pressure fluctuations.
- High solenoid and return spring forces ensure high speed and precise repeatability.
- Built-in wear compensation - valve stroke is shorter than solenoid stroke.
- Constant high flow maintained throughout the pressure range.
- Exhaust contaminants are isolated from the solenoid.
- Full flow exhaust.
- Universal porting - 6 functions in one valve.

Function	Port size (Inlet & Exhaust)	Flow (Max)	Circuit bar mounting	Profile
3/2 NO-NC	1/4" - 3/8"	0.5C_v	non plug-in cylinder ports in valve	26 mm 38 mm

OPERATIONAL BENEFITS

1. Direct solenoid operated valve.
2. Balanced poppet, immune to variations of pressure.
3. Short stroke with high flow.
4. The patented solenoid develops high shifting forces.
5. Powerful return spring.
6. Manual operator standard on all valves.

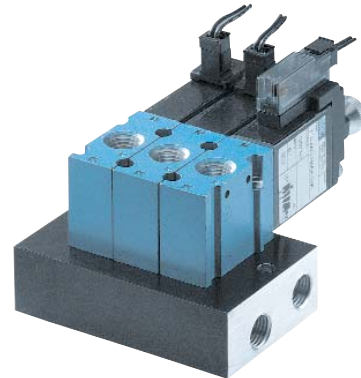

HOW TO ORDER

37A-xxx-Hxxx-xxx

HOW TO ORDER VALVE FOR CIRCUIT BAR MOUNTING

Valve port size	Universal valve	NC only valve
1/8" NPTF	<input type="radio"/> 37A-EGO-Hxxx-xxx	<input type="radio"/> 37A-FGO-Hxxx-xxx
1/4" NPTF	<input type="radio"/> 37A-EHO-Hxxx-xxx	<input type="radio"/> 37A-FHO-Hxxx-xxx

SOLENOID OPERATOR >

H **XX X- X XX**

XX Voltage	X Wire length	X Manual operator	XX Electrical connection
<input type="radio"/> DC 24VDC (1.8 W)	<input type="radio"/> A 18"	<input type="radio"/> 1 Non-locking	<input type="radio"/> MA Plug-in wire assy
<input type="radio"/> DB 24VDC (2.4 W)	<input type="radio"/> C 36"		<input type="radio"/> MC Plug-in wire assy with light
<input type="radio"/> DA 24VDC (5.2 W)	<input type="radio"/> x Other Options		<input type="radio"/> BA Flying leads
<input type="radio"/> AA 120VAC (must use with rectified connector)			<input type="radio"/> BC Flying leads with light
<input type="radio"/> xx Other Options			<input type="radio"/> HA Plug-in connector with rectifier and light
			<input type="radio"/> xx Other Options

EBM37A-xxxxx-xx

HOW TO ORDER CIRCUIT BAR (REGULATORS ORDERED SEPARATELY)**

Port size COMMON INLET & EXHAUST	Without regulators (20mm)	With regulators (20mm)
26mm Profile 1/4" NPTF	<input type="radio"/> EBM37A-01CAK-xx	-
38mm Profile 3/8" NPTF	-	<input type="radio"/> EBM37A-01JAK-xx

Number of stations (03=3 stations)

Note : clic for valves mounted on base at the factory, add - 9 to the model number.

** Pressure Regulators :

PR37A-GOAx

- X=A (0 to 120 PSI)
- X=B (0 to 80 PSI)
- X=C (0 to 30 PSI)

**TECHNICAL
DATA**

Fluid :	Compressed air, vacuum, inert gases
Pressure range :	Vacuum to 120 PSI
Lubrication :	Not required, if used select a medium aniline point lubricant (between 180°F and 210°F)
Filtration :	40 µ
Temperature range :	0°F to 120°F (-18°C to 50°C)
Orifice :	4.3 mm
Flow (at 6 bar, ΔP=1bar) :	5.2 W : 0.50C _v , 2.4 W : 0.25C _v , 1.8 W : 0.15C _v
Coil :	General purpose class A, continuous duty, encapsulated
Voltage range :	-15% to +10% of nominal voltage
Power :	5.2 W - 2.4 W - 1.8 W - 1.0 W
Response times :	Energize : 17.0 ms
(with 5.2 W coil)	De-energize : 6.0 ms

- Note : • Valve and coil are not interchangeable.
- Spare parts : • Seal between valve and bar : 16630. • Mounting screw (x2) : 35043. • Blanking plate : M-37002.
• Regulator blanking plate : R-47003.
- Options : • Isolation of inlet and/or exhaust. Special bar. Consult factory. • BSPP Threads.

DIMENSIONS

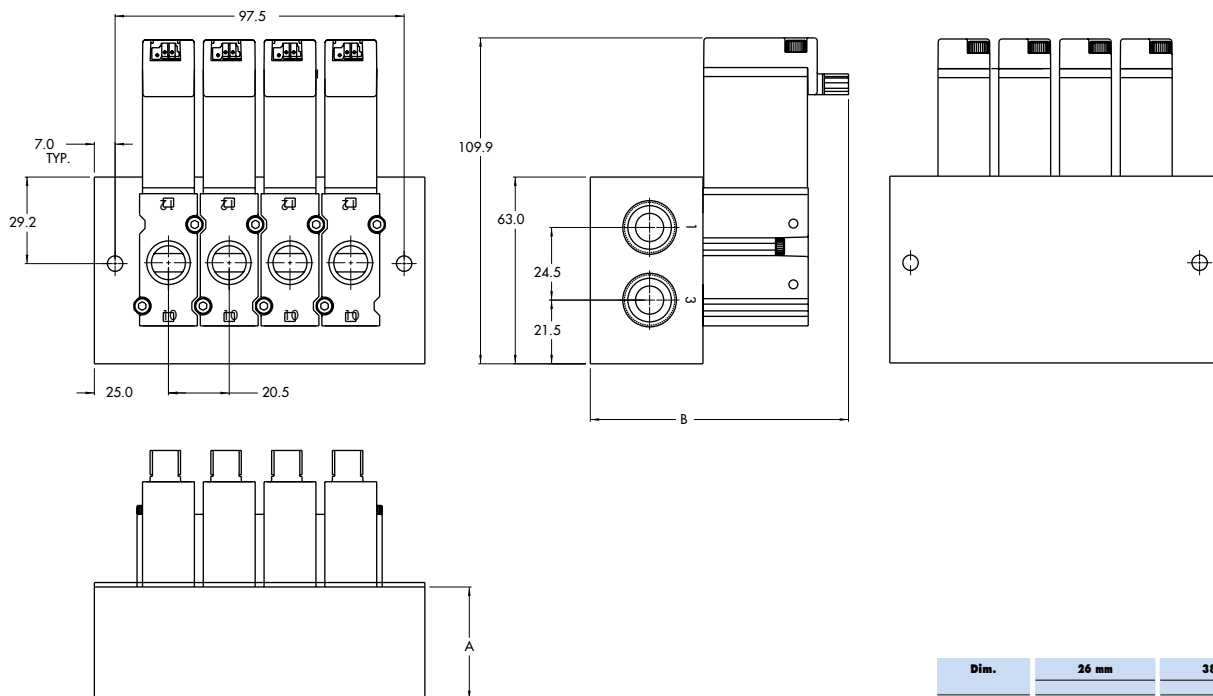

Function	Port size	Flow [Max]	Circuit bar mounting	Profile
3/2 NO-NC	1/8" - 1/4" 6 mm tube receptacle	0.5C_v	non plug-in cylinder ports in base	26 mm

OPERATIONAL BENEFITS

1. Direct solenoid operated valve.
2. Balanced poppet, immune to variations of pressure.
3. Short stroke with high flow.
4. The patented solenoid develops high shifting forces.
5. Powerful return spring.
6. Manual operator standard on all valves.

Reset

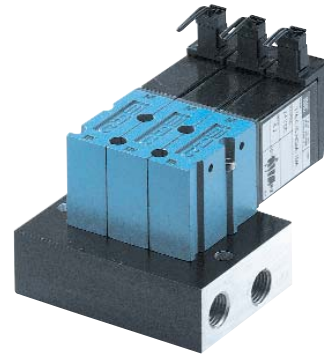

HOW TO ORDER

37A-xxx-Hxxx-xxx

HOW TO ORDER VALVE FOR CIRCUIT BAR MOUNTING

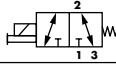
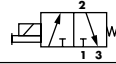
Port size (see base)	Universal valve	NC only valve
		
Valve less base	<input type="radio"/> 37A-C10-Hxxx-xxx	<input type="radio"/> 37A-D10-Hxxx-xxx

SOLENOID OPERATOR

H XX X- X XX

XX Voltage	X Wire length	X Manual operator	XX Electrical connection
<input type="radio"/> DC 24VDC (1.8 W)	<input type="radio"/> A 18"	<input type="radio"/> 1 Non-locking	<input type="radio"/> MA Plug-in wire assy
<input type="radio"/> DB 24VDC (2.4 W)	<input type="radio"/> C 36"		<input type="radio"/> MC Plug-in wire assy with light
<input type="radio"/> DA 24VDC (5.2 W)	<input type="radio"/> X Other Options		<input type="radio"/> BA Flying leads
<input type="radio"/> AA 120VAC (must use with rectified connector)			<input type="radio"/> BC Flying leads with light
<input type="radio"/> xx Other Options			<input type="radio"/> HA Plug-in connector with rectifier and light
			<input type="radio"/> xx Other Options

EBM37A-00xxx-xx

HOW TO ORDER CIRCUIT BAR

Port size	Side cylinder ports (18 mm)	Bottom cylinder ports (18 mm)
1/8" NPTF	<input type="radio"/> EBM37A-00AAA-xx	<input type="radio"/> EBM37A-00BAA-xx
1/4" NPTF	<input type="radio"/> EBM37A-00AAB-xx	<input type="radio"/> EBM37A-00BAB-xx
6 mm tube receptacle	<input type="radio"/> EBM37A-00AAG-xx	<input type="radio"/> EBM37A-00BAG-xx

Number of stations (03=3 stations)

Note: clic for valves mounted on base at the factory, add - 9 to the model number.

**TECHNICAL
DATA**

Fluid :	Compressed air, vacuum, inert gases
Pressure range :	Vacuum to 120 PSI
Lubrication :	Not required, if used select a medium aniline point lubricant (between 180°F and 210°F)
Filtration :	40 µ
Temperature range :	0°F to 120°F (-18°C to 50°C)
Orifice :	4.3 mm
Flow (at 6 bar, ΔP=1bar) :	5.2 W : 0.50C _v , 2.4 W : 0.25C _v , 1.8 W : 0.15C _v
Coil :	General purpose class A, continuous duty, encapsulated
Voltage range :	-15% to +10% of nominal voltage
Power :	5.2 W - 2.4 W - 1.8 W - 1.0 W
Response times :	Energize : 17.0 ms
(with 5.2 W coil)	De-energize : 6.0 ms

- Note : • Valve and coil are not interchangeable.
- Spare parts : • Seal between valve and bar : 16630. • Mounting screw (x2) : 35043. • Blanking plate : M-37001.
- Options : • Isolation of inlet and/or exhaust. Special bar. Consult factory. • BSPP Threads.

DIMENSIONS

Dim.	1/4"	M6 Carstick
"B"	16.5	18.5

Number of stations	1	2	3	4	5	6	7	8	9	10
"A"	50.0	68.0	86.0	104.0	122.0	140.0	158.0	176.0	194.0	212.0

Dimensions are based on 18 mm centerline spacing

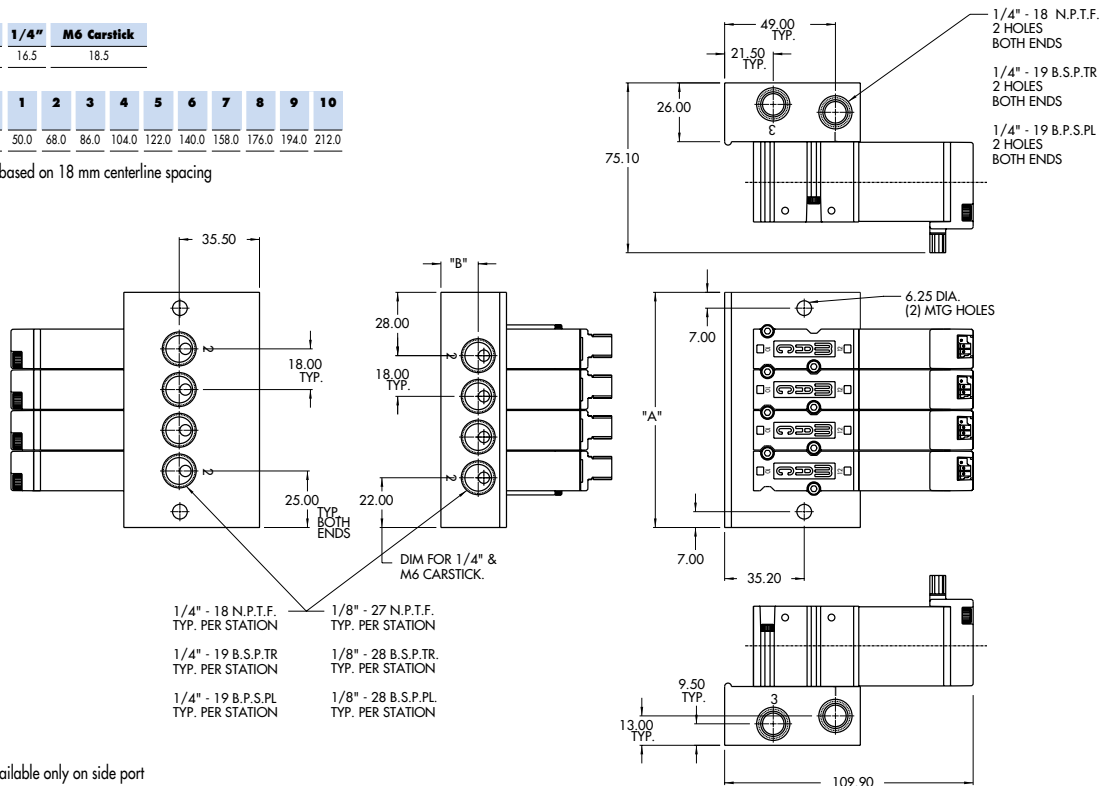

* M6 Carstick available only on side port

Function	Port size	Flow [Max]	Circuit bar mounting	Profile
3/2 NO-NC	1/8" - 1/4" 6 mm tube receptacle	0.5C_v	non plug-in cylinder ports in base with Pr. Reg.	38 mm

OPERATIONAL BENEFITS

1. Direct solenoid operated valve.
2. Balanced poppet, immune to variations of pressure.
3. Short stroke with high flow.
4. The patented solenoid develops high shifting forces.
5. Powerful return spring.
6. Manual operator standard on all valves.

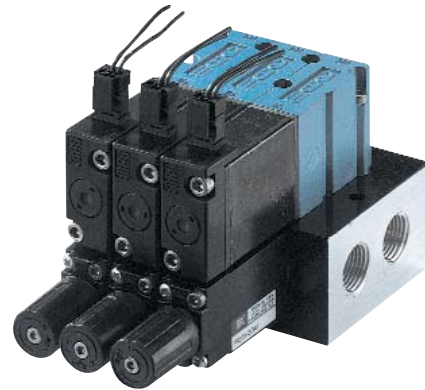

Reset

HOW TO ORDER

37A-xxx-Hxxx-xxx

HOW TO ORDER VALVE FOR CIRCUIT BAR MOUNTING

Port size (see base)	Universal valve	NC only valve
Valve less base	<input type="radio"/> 37A-C1O-Hxxx-xxx	<input type="radio"/> 37A-D1O-Hxxx-xxx

SOLENOID OPERATOR >

H XX X- X XX'

Voltage		Wire length		Manual operator		Electrical connection	
<input type="radio"/> DC	24VDC (1.8 W)	<input type="radio"/> A	18"	<input type="radio"/> 1	Non-locking	<input type="radio"/> MA	Plug-in wire assy
<input type="radio"/> DB	24VDC (2.4 W)	<input type="radio"/> C	36"			<input type="radio"/> MC	Plug-in wire assy with light
<input type="radio"/> DA	24VDC (5.2 W)	<input type="radio"/> x	Other Options			<input type="radio"/> BA	Flying leads
<input type="radio"/> AA	120VAC (must use with rectified connector)					<input type="radio"/> BC	Flying leads with light
<input type="radio"/> xx	Other Options					<input type="radio"/> HA	Plug-in connector with rectifier and light
						<input type="radio"/> xx	Other Options

EBM37A-00xxx-xx

HOW TO ORDER CIRCUIT BAR (REGULATORS ORDERED SEPARATELY)**

Port size	Side cylinder ports (18 mm)	Bottom cylinder ports (18 mm)
1/8" NPTF	<input type="radio"/> EBM37A-00FAA-xx	<input type="radio"/> EBM37A-00GAA-xx
1/4" NPTF	<input type="radio"/> EBM37A-00FAB-xx	<input type="radio"/> EBM37A-00GAB-xx
6 mm tube receptacle	<input type="radio"/> EBM37A-00FAG-xx	<input type="radio"/> EBM37A-00GAG-xx

Number of stations (03=3 stations)

Note : clic for valves mounted on base at the factory, add - 9 to the model number.

** Pressure Regulators :

PR37A-GOAx

- X=A (0 to 120 PSI)
- X=B (0 to 80 PSI)
- X=C (0 to 30 PSI)

**TECHNICAL
DATA**

Fluid :	Compressed air, vacuum, inert gases
Pressure range :	Vacuum to 120 PSI
Lubrication :	Not required, if used select a medium aniline point lubricant (between 180°F and 210°F)
Filtration :	40 µ
Temperature range :	0°F to 120°F (-18°C to 50°C)
Orifice :	4.3 mm
Flow (at 6 bar, ΔP=1bar) :	5.2 W : 0.50C _v , 2.4 W : 0.25C _v , 1.8 W : 0.15C _v
Coil :	General purpose class A, continuous duty, encapsulated
Voltage range :	-15% to +10% of nominal voltage
Power :	5.2 W - 2.4 W - 1.8 W - 1.0 W
Response times :	Energize : 17.0 ms
(with 5.2 W coil)	De-energize : 6.0 ms

- Note : • Valve and coil are not interchangeable.
- Spare parts : • Seal between valve and bar : 16630. • Mounting screw (x2) : 35043. • Blanking plate : M-37001.
• Regulator blanking plate : R-47003.
- Options : • Isolation of inlet and/or exhaust. Special bar. Consult factory. • BSPP Threads.

DIMENSIONS

Number of stations	2	3	4	5	6	7	8	9	10	11
"A"	63.7	81.7	99.7	117.7	135.7	153.7	171.7	189.7	207.7	225.7

Dimensions are based on 18 mm centerline spacing

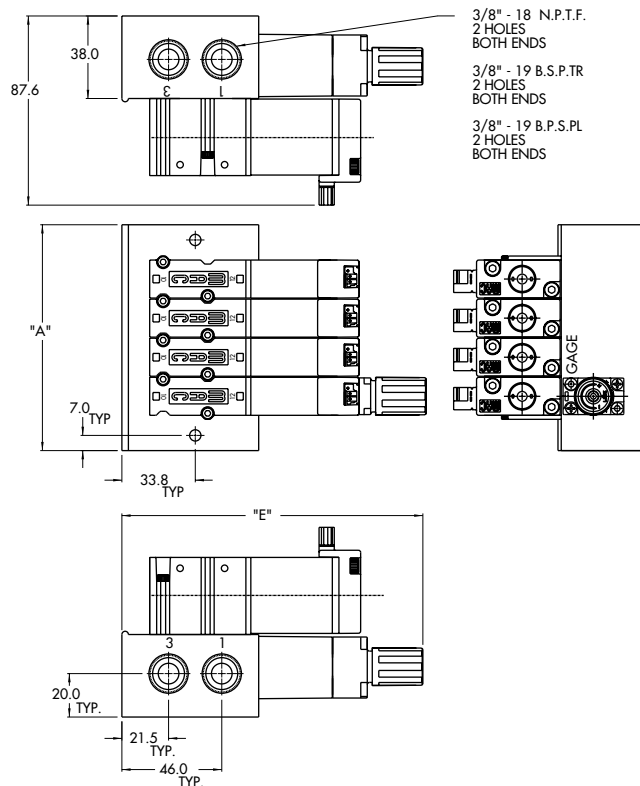
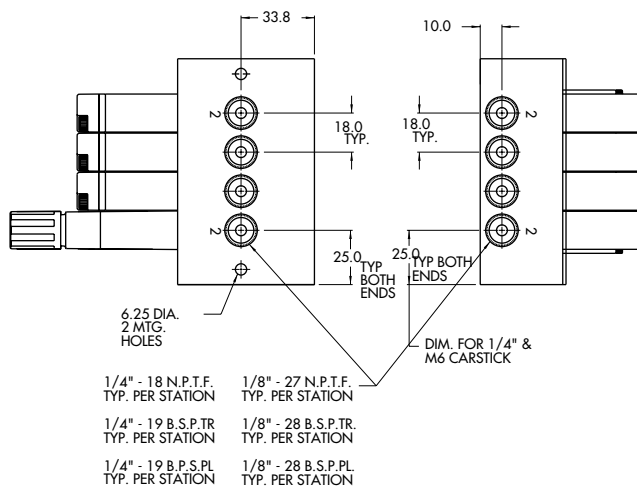

Dim.	Regulator with locking adjusting screw	Regulator with adjusting screw	Regulator with adjusting knob
"E"	135.8	131.8	139.6

* M6 Carstick available only on side port

Note: Bottom & side cylinder ports not available on the same station

Function	Port size	Flow [Max]	Circuit bar mounting	Profile
3/2 NO-NC	1/8" - 1/4" 6 mm tube receptacle	0.5C_v	non plug-in add-on style cylinder ports in base	38 mm

OPERATIONAL BENEFITS

1. Direct solenoid operated valve.
2. Balanced poppet, immune to variations of pressure.
3. Short stroke with high flow.
4. The patented solenoid develops high shifting forces.
5. Powerful return spring.
6. Manual operator standard on all valves.

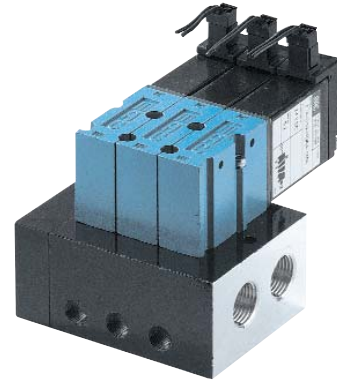

Reset

HOW TO ORDER

37A-xxx-Hxxx-xxx

HOW TO ORDER VALVE FOR CIRCUIT BAR MOUNTING

Port size (see base)	Universal valve	NC only valve
Valve less base	<input type="radio"/> 37A-C1O-Hxxx-xxx	<input type="radio"/> 37A-D1O-Hxxx-xxx

SOLENOID OPERATOR >

H **xx x- x xx**

Voltage	Wire length	Manual operator	Electrical connection
<input type="radio"/> DC 24VDC (1.8 W)	<input type="radio"/> A 18"	<input type="radio"/> I Non-locking	<input type="radio"/> MA Plug-in wire Assy
<input type="radio"/> DB 24VDC (2.4 W)	<input type="radio"/> C 36"		<input type="radio"/> MC Plug-in wire Assy with light
<input type="radio"/> DA 24VDC (5.2 W)	<input type="radio"/> X Other Options		<input type="radio"/> BA Flying leads
<input type="radio"/> AA 120VAC (must use with rectified connector)			<input type="radio"/> BC Flying leads with light
<input type="radio"/> XX Other Options			<input type="radio"/> HA Plug-in connector with rectifier and light
			<input type="radio"/> XX Other Options

EBM37A-00xxx-xx

HOW TO ORDER CIRCUIT BAR

Port size	Side cylinder ports (18 mm)	Bottom cylinder ports (18 mm)
1/8" NPTF	<input type="radio"/> EBM37A-00DBA-xx	<input type="radio"/> EBM37A-00EBA-xx
1/4" NPTF	<input type="radio"/> EBM37A-00DBB-xx	<input type="radio"/> EBM37A-00EBB-xx
6 mm tube receptacle	<input type="radio"/> EBM37A-00DBG-xx	<input type="radio"/> EBM37A-00EBG-xx

Number of stations (03=3 stations)

Note: clic for valves mounted on base at the factory, add - 9 to the model number.
add-a-unit stations may be added to above bars. Clic here for model numbers.

**TECHNICAL
DATA**

Fluid :	Compressed air, vacuum, inert gases
Pressure range :	Vacuum to 120 PSI
Lubrication :	Not required, if used select a medium aniline point lubricant (between 180°F and 210°F)
Filtration :	40 µ
Temperature range :	0°F to 120°F (-18°C to 50°C)
Orifice :	4.3 mm
Flow (at 6 bar, ΔP=1bar) :	5.2 W : 0.50C _v , 2.4 W : 0.25C _v , 1.8 W : 0.15C _v
Coil :	General purpose class A, continuous duty, encapsulated
Voltage range :	-15% to +10% of nominal voltage
Power :	5.2 W - 2.4 W - 1.8 W - 1.0 W
Response times :	Energize : 17.0 ms
(with 5.2 W coil)	De-energize : 6.0 ms

- Note : • Valve and coil are not interchangeable.
- Spare parts : • Seal between valve and bar : 16630. • Mounting screw (x2) : 35043. • Blanking plate : M-37001. • End plate Kit : M-37005-0
- Options : • Isolation of inlet and/or exhaust. Special bar. Consult factory. • BSPP Threads.

DIMENSIONS

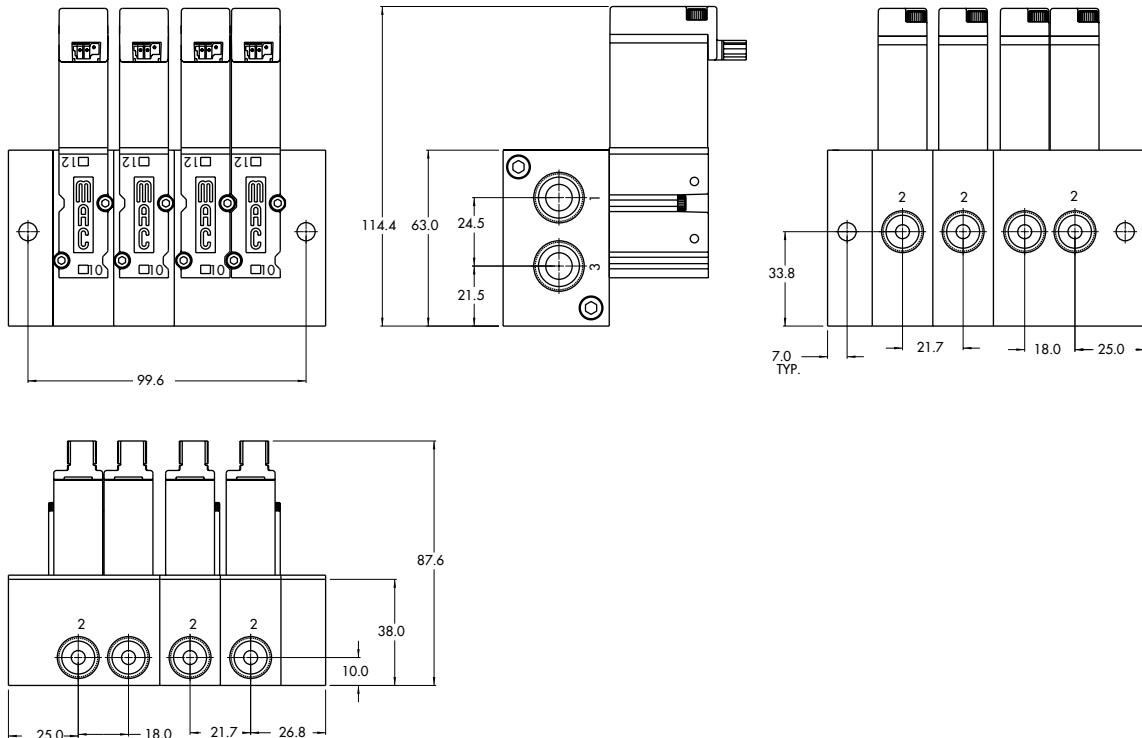

Note: Bottom & side cylinder ports not available on the same station

Function	Port size	Flow [Max]	Circuit bar mounting	Profile
3/2 NO-NC	1/8" - 1/4" 6 mm tube receptacle	0.5C_v	non plug-in odd-a-unit stations	38 mm

OPERATIONAL BENEFITS

1. Direct solenoid operated valve.
2. Balanced poppet, immune to variations of pressure.
3. Short stroke with high flow.
4. The patented solenoid develops high shifting forces.
5. Powerful return spring.
6. Manual operator standard on all valves.

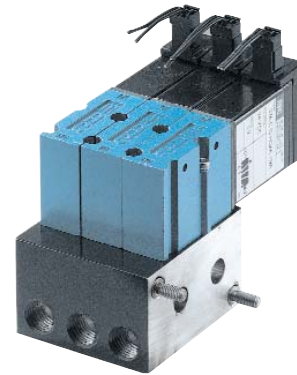

Reset

HOW TO ORDER

37A-xxx-Hxxx-xxx

HOW TO ORDER VALVE FOR CIRCUIT BAR MOUNTING

Port size (see base)	Universal valve	NC only valve
Valve less base	<input type="radio"/> 37A-C1O-Hxxx-xxx	<input type="radio"/> 37A-D1O-Hxxx-xxx

SOLENOID OPERATOR >

H **xx x-x xx'**

Voltage		Wire length		Manual operator		Electrical connection	
<input type="radio"/> DC	24VDC (1.8 W)	<input type="radio"/> A	18"	<input type="radio"/> I	Non-locking	<input type="radio"/> MA	Plug-in wire Assy
<input type="radio"/> DB	24VDC (2.4 W)	<input type="radio"/> c	36"			<input type="radio"/> MC	Plug-in wire Assy with light
<input type="radio"/> DA	24VDC (5.2 W)	<input type="radio"/> x	Other Options			<input type="radio"/> BA	Flying leads
<input type="radio"/> AA	120VAC (must use with rectified connector)					<input type="radio"/> BC	Flying leads with light
<input type="radio"/> xx	Other Options					<input type="radio"/> HA	Plug-in connector with rectifier and light
						<input type="radio"/> xx	Other Options

EBM37A-00xxx-xx

HOW TO ORDER CIRCUIT BAR

Port size	Side cylinder ports (18 mm)	Bottom cylinder ports (18 mm)
1/8" NPTF	<input type="radio"/> EBM37A-00DCA-xx	<input type="radio"/> EBM37A-00ECA-xx
1/4" NPTF	<input type="radio"/> EBM37A-00DCB-xx	<input type="radio"/> EBM37A-00ECB-xx
6 mm tube receptacle	<input type="radio"/> EBM37A-00DCG-xx	<input type="radio"/> EBM37A-00ECG-xx

Number of stations (01, 02, 03 or 04)

Note : clic for valves mounted on base at the factory, add - 9 to the model number.

**TECHNICAL
DATA**

Fluid :	Compressed air, vacuum, inert gases
Pressure range :	Vacuum to 120 PSI
Lubrication :	Not required, if used select a medium aniline point lubricant (between 180°F and 210°F)
Filtration :	40 µ
Temperature range :	0°F to 120°F (-18°C to 50°C)
Orifice :	4.3 mm
Flow (at 6 bar, ΔP=1bar) :	5.2 W : 0.50C _v , 2.4 W : 0.25C _v , 1.8 W : 0.15C _v
Coil :	General purpose class A, continuous duty, encapsulated
Voltage range :	-15% to +10% of nominal voltage
Power :	5.2 W - 2.4 W - 1.8 W - 1.0 W
Response times :	Energize : 17.0 ms
(with 5.2 W coil)	De-energize : 6.0 ms

- Note :
 - Valve and coil are not interchangeable.
- Spare parts :
 - Seal between valve and bar : 16630. • Mounting screw (x2) : 35043. • Blanking plate : M-37001.
 - O-ring port seal (x2) : 17015-01. • Tie rod (x2) : 79007-01 (one station length)
- Options :
 - Isolation of inlet and/or exhaust. Special bar. Consult factory. • BSPP Threads.

DIMENSIONS

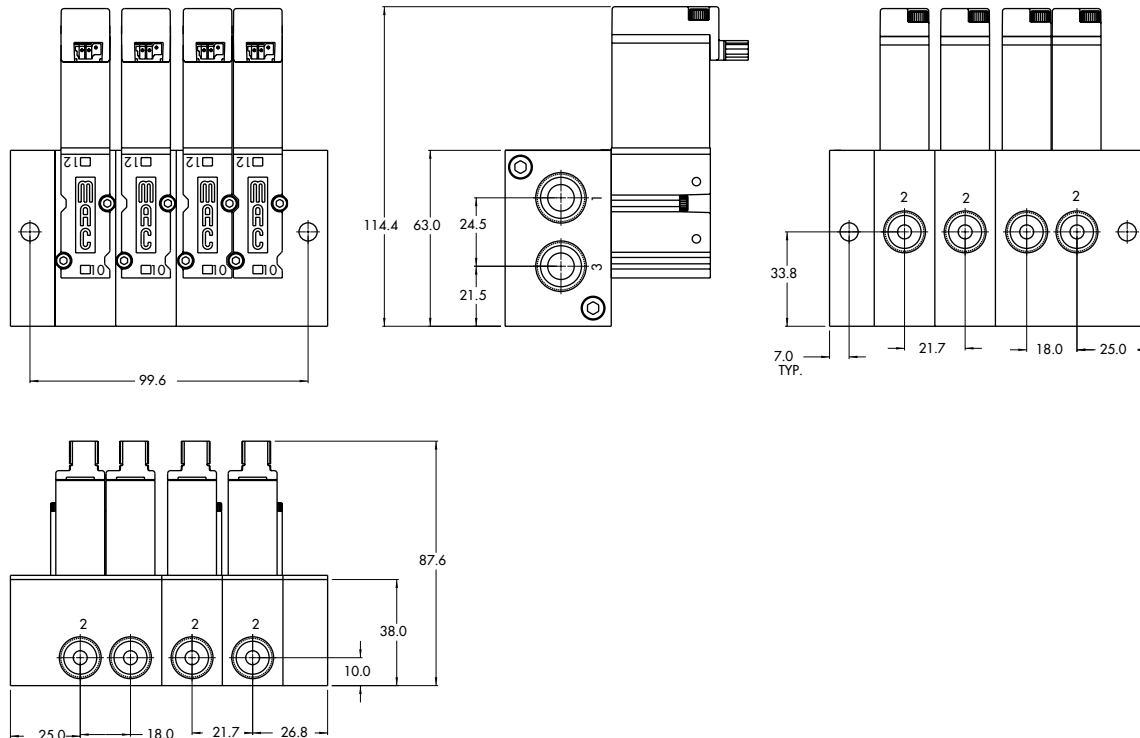

Note: Bottom & side cylinder ports not available on the same station

Function	Port size	Flow [Max]	Circuit bar mounting	Profile
3/2 NO-NC	1/8" - 1/4" 6 mm tube receptacle	0.5C_v	plug-in	32.5 mm

OPERATIONAL BENEFITS

1. Direct solenoid operated valve.
2. Balanced poppet, immune to variations of pressure.
3. Short stroke with high flow.
4. The patented solenoid develops high shifting forces.
5. Powerful return spring.
6. Manual operator standard on all valves.



Reset

HOW TO ORDER

37A-xxx-HxxP-xxx

HOW TO ORDER VALVE FOR CIRCUIT BAR MOUNTING

Port size (see base)	Universal valve	NC only valve
Valve less base	<input type="radio"/> 37A-C1O-HxxP-xxx	<input type="radio"/> 37A-D1O-HxxP-xxx

SOLENOID OPERATOR >

H XX P- X XX'

XX Voltage	X Manual operator	XX Electrical connection
<input type="radio"/> DC 24VDC (1.8 W)	<input type="radio"/> 1 Non-locking	<input type="radio"/> FA Plug-in
<input type="radio"/> DB 24VDC (2.4 W)		<input type="radio"/> FC Plug-in with light
<input type="radio"/> DA 24VDC (5.2 W)		<input type="radio"/> FE Plug-in with suppression diode
<input type="radio"/> AA 120VAC (Mod. No. required see below)		<input type="radio"/> FG Plug-in with suppression diode with LED light
<input type="radio"/> xx Other Options		<input type="radio"/> xx Other Options

HOW TO ORDER "PLUG-IN" CIRCUIT BAR**

ECD37A-xxxxx-xxxx

Port size	Spacing mm	Side cylinder ports	Bottom cylinder ports
1/8" NPTF	18	<input type="radio"/> ECD37A-00AAA-A0xx	<input type="radio"/> ECD37A-00BAA-A0xx
1/4" NPTF	18	<input type="radio"/> ECD37A-00AAB-A0xx	<input type="radio"/> ECD37A-00BAB-A0xx
6 mm tube receptacle	18	<input type="radio"/> ECD37A-00AAG-A0xx	<input type="radio"/> ECD37A-00BAG-A0xx
1/8" NPTF	30	<input type="radio"/> ECD37A-01AAA-C0xx	<input type="radio"/> ECD37A-01BAA-C0xx
1/4" NPTF	30	<input type="radio"/> ECD37A-01AAB-C0xx	<input type="radio"/> ECD37A-01BAB-C0xx
6 mm tube receptacle	30	<input type="radio"/> ECD37A-01AAG-C0xx	<input type="radio"/> ECD37A-01BAG-C0xx

Number of stations (03=3 stations)
 Note : clic for valves mounted on base at the factory, add - 9 to the model number.
 clic for multi-pin connector (9, 15 or 25).
 for AC voltage use mod. FWR2 after circuit bar model number.

- A0 = without light
- AA = with light (120V)
- AB = with light (240V)
- AD = with light (24V)
- C0 = terminal strip

**T E C H N I C A L
D A T A**

Fluid :	Compressed air, vacuum, inert gases
Pressure range :	Vacuum to 120 PSI
Lubrication :	Not required, if used select a medium aniline point lubricant (between 180°F and 210°F)
Filtration :	40 µ
Temperature range :	0°F to 120°F (-18°C to 50°C)
Orifice :	4.3 mm
Flow (at 6 bar, ΔP=1bar) :	5.2 W : 0.50C _v , 2.4 W : 0.25C _v , 1.8 W : 0.15C _v
Coil :	General purpose class A, continuous duty, encapsulated
Voltage range :	-15% to +10% of nominal voltage
Power :	5.2 W - 2.4 W - 1.8 W - 1.0 W
Response times :	Energize : 17.0 ms
(with 5.2 W coil)	De-energize : 6.0 ms

- Note : • Valve and coil are not interchangeable.
- Spare parts : • Seal between valve and bar : 16630. • Mounting screw (x2) : 35043. • Blanking plate : M-37001.
• Base wire plug-in protector : 16520.
- Options : • Isolation of inlet and/or exhaust. Special bar. Consult factory. • BSPP Threads.

D I M E N S I O N S

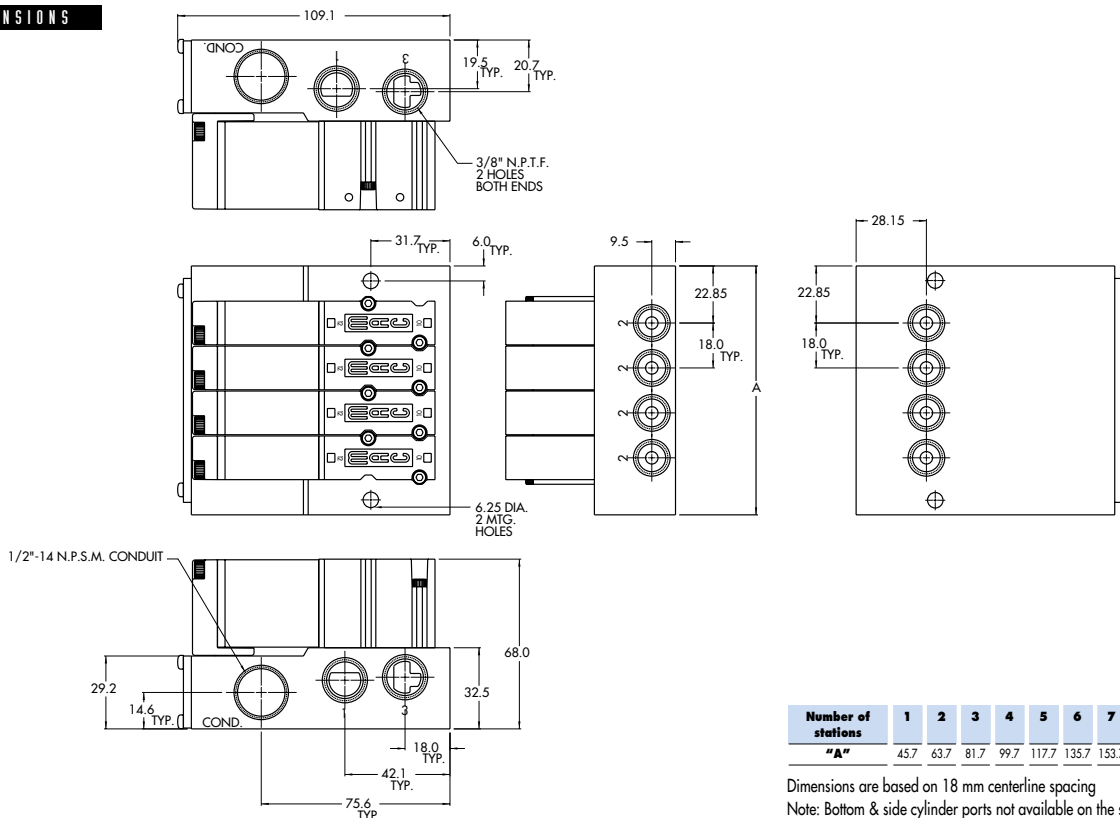

Number of stations	1	2	3	4	5	6	7	8	9	10
"A"	45.7	63.7	81.7	99.7	117.7	135.7	153.7	171.7	189.7	207.7

Dimensions are based on 18 mm centerline spacing
Note: Bottom & side cylinder ports not available on the same station

Function	Port size	Flow [Max]	Circuit bar mounting	Profile
3/2 NO-NC	1/8" - 1/4"	0.5C_v	plug-in with Pr. Reg.	44 mm

OPERATIONAL BENEFITS

1. Direct solenoid operated valve.
2. Balanced poppet, immune to variations of pressure.
3. Short stroke with high flow.
4. The patented solenoid develops high shifting forces.
5. Powerful return spring.
6. Manual operator standard on all valves.

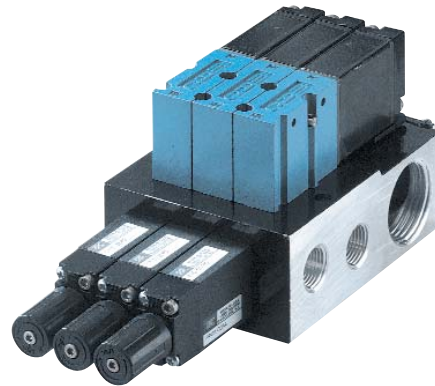

HOW TO ORDER

37A-xxx-HxxP-xxx

HOW TO ORDER VALVE FOR CIRCUIT BAR MOUNTING

Port size (see base)	Universal valve	NC only valve
Valve less base	<input type="radio"/> 37A-C1O-HxxP-xxx	<input type="radio"/> 37A-D1O-HxxP-xxx

SOLENOID OPERATOR >

H XX P- X XX*

XX Voltage	X Manual operator	XX Electrical connection
<input type="radio"/> DC 24VDC (1.8 W)	<input type="radio"/> 1 Non-locking	<input type="radio"/> FA Plug-in
<input type="radio"/> DB 24VDC (2.4 W)		<input type="radio"/> FC Plug-in with light
<input type="radio"/> DA 24VDC (5.2 W)		<input type="radio"/> FE Plug-in with suppression diode
<input type="radio"/> AA 120VAC (Mod. No. required see below)		<input type="radio"/> FG Plug-in with suppression diode with LED light
<input type="radio"/> xx Other Options		<input type="radio"/> xx Other Options

HOW TO ORDER "PLUG-IN" CIRCUIT BAR (REGULATORS ORDERED SEPARATELY)**

ECD37A-xxxxx-xxxx

Port size	Spacing mm	Bottom cylinder ports
1/8" NPTF	18	<input type="radio"/> ECD37A-00CDA-A0xx
1/4" NPTF	18	<input type="radio"/> ECD37A-00CDB-A0xx
1/8" NPTF	30	<input type="radio"/> ECD37A-01CDA-C0xx
1/4" NPTF	30	<input type="radio"/> ECD37A-01CDB-C0xx

Number of stations (03=3 stations)

** Other options available, consult factory.

Note : clic for valves mounted on base at the factory, add - 9 to the model number.
 clic for multi-pin connector (9, 15 or 25).
 for AC voltage use mod. FWR2 after circuit bar model number.

** Pressure Regulators :

- PR37A-GOAx**
- X=A (0 to 120 PSI)
 - X=B (0 to 80 PSI)
 - X=C (0 to 30 PSI)

- A0 = without light
- AA = with light (120V)
- AB = with light (240V)
- AD = with light (24V)
- C0 = terminal strip
- CA = terminal strip with light (120V)
- CB = terminal strip with light (240V)
- CD = terminal strip with light (24V)

**TECHNICAL
DATA**

Fluid :	Compressed air, vacuum, inert gases
Pressure range :	Vacuum to 120 PSI
Lubrication :	Not required, if used select a medium aniline point lubricant (between 180°F and 210°F)
Filtration :	40 µ
Temperature range :	0°F to 120°F (-18°C to 50°C)
Orifice :	4.3 mm
Flow (at 6 bar, ΔP=1bar) :	5.2 W : 0.50C _v , 2.4 W : 0.25C _v , 1.8 W : 0.15C _v
Coil :	General purpose class A, continuous duty, encapsulated
Voltage range :	-15% to +10% of nominal voltage
Power :	5.2 W - 2.4 W - 1.8 W - 1.0 W
Response times :	Energize : 17.0 ms
(with 5.2 W coil)	De-energize : 6.0 ms

- Note : • Valve and coil are not interchangeable.
- Spare parts : • Seal between valve and bar : 16630. • Mounting screw (x2) : 35043. • Blanking plate : M-37001.
• Base wire plug-in protector : 16520. • Regulator blanking plate : R-47003.
- Options : • Isolation of inlet and/or exhaust. Special bar. Consult factory. • BSPP Threads.

DIMENSIONS

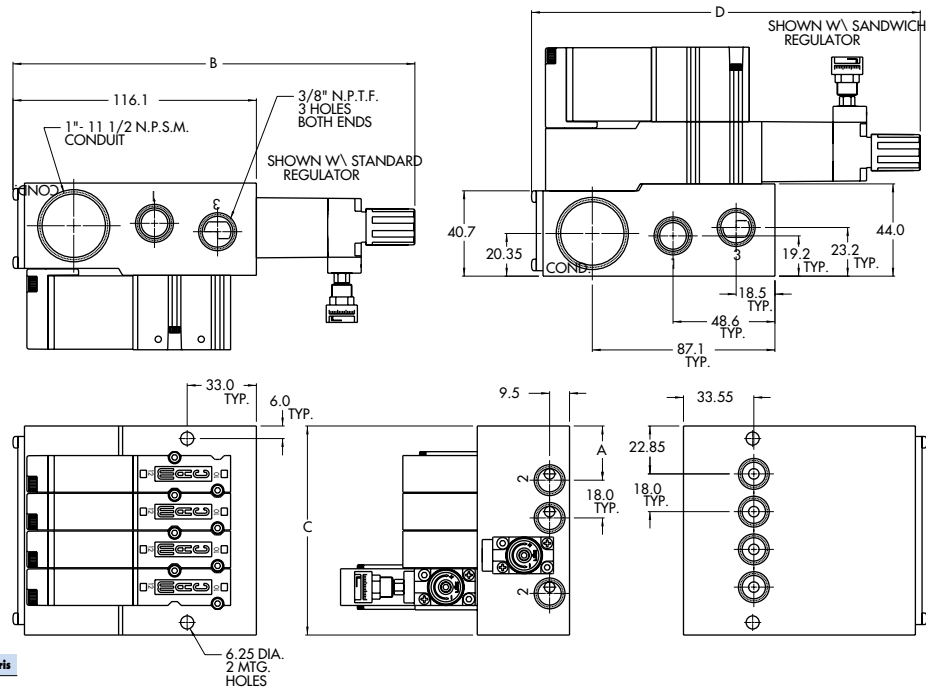

Dim.	1/4"	1/8"	6 mm Legris
"A"	25.85	25.85	22.85

Dim.	Regulator with locking adjusting screw	Regulator with adjusting screw	Regulator with adjusting knob
"B"	188.8	184.7	191.7
"D"	182.5	178.4	185.4

Number of stations	1	2	3	4	5	6	7	8	9	10
"C"	45.7	63.7	81.7	99.7	117.7	135.7	153.7	171.7	189.7	207.7

Dimensions are based on 18 mm centerline spacing
Note: Bottom & side cylinder ports not available on the same station

Function	Port size	Flow [Max]	Circuit bar mounting	Profile
3/2 NO-NC	1/8" - 1/4" 6 mm tube receptacle	0.5C_v	add-on style plug-in	44 mm

OPERATIONAL BENEFITS

1. Direct solenoid operated valve.
2. Balanced poppet, immune to variations of pressure.
3. Short stroke with high flow.
4. The patented solenoid develops high shifting forces.
5. Powerful return spring.
6. Manual operator standard on all valves.



HOW TO ORDER

37A-xxx-HxxP-xxx

HOW TO ORDER VALVE FOR CIRCUIT BAR MOUNTING

Port size (see base)	Universal valve	NC only valve
Valve less base	<input type="radio"/> 37A-C1O-HxxP-xxx	<input type="radio"/> 37A-D1O-HxxP-xxx

SOLENOID OPERATOR >

H **XX** P- **X** **XX**

XX Voltage	X Manual operator	XX Electrical connection
<input type="radio"/> DC 24VDC (1.8 W)	<input type="radio"/> 1 Non-locking	<input type="radio"/> FA Plug-in
<input type="radio"/> DB 24VDC (2.4 W)		<input type="radio"/> FC Plug-in with light
<input type="radio"/> DA 24VDC (5.2 W)		<input type="radio"/> FE Plug-in with suppression diode
<input type="radio"/> AA 120VAC (Mod. No. required see below)		<input type="radio"/> FG Plug-in with suppression diode with LED light
<input type="radio"/> xx Other Options		<input type="radio"/> xx Other Options

HOW TO ORDER "PLUG-IN" CIRCUIT BAR**

ECD37A-xxxxx-xxxx

Port size	Spacing mm	Side cylinder ports	Bottom cylinder ports
1/8" NPTF	18	<input type="radio"/> ECD37A-00AEA-A0xx	<input type="radio"/> ECD37A-00BEA-A0xx
1/4" NPTF	18	<input type="radio"/> ECD37A-00AEB-A0xx	<input type="radio"/> ECD37A-00BEB-A0xx
6 mm tube receptacle	18	<input type="radio"/> ECD37A-00AEG-A0xx	<input type="radio"/> ECD37A-00BEG-A0xx
1/8" NPTF	30	<input type="radio"/> ECD37A-01AEA-C0xx	<input type="radio"/> ECD37A-01BEA-C0xx
1/4" NPTF	30	<input type="radio"/> ECD37A-01AEB-C0xx	<input type="radio"/> ECD37A-01BEB-C0xx
6 mm tube receptacle	30	<input type="radio"/> ECD37A-01AEG-C0xx	<input type="radio"/> ECD37A-01BEG-C0xx

Number of stations (03=3 stations)

** Other options available, consult factory.

Note : clic for valves mounted on base at the factory, add - 9 to the model number.
 clic for multi-pin connector (9, 15 or 25).

for AC voltage use mod. FWR2 after circuit bar model number.

add-a-unit stations may be added to above bars. Clic here for model numbers.

- A0 = without light
- AA = with light (120V)
- AB = with light (240V)
- AD = with light (24V)
- C0 = terminal strip
- CA = terminal strip with light (120V)
- CB = terminal strip with light (240V)
- CD = terminal strip with light (24V)

**TECHNICAL
DATA**

Fluid :	Compressed air, vacuum, inert gases
Pressure range :	Vacuum to 120 PSI
Lubrication :	Not required, if used select a medium aniline point lubricant (between 180°F and 210°F)
Filtration :	40 µ
Temperature range :	0°F to 120°F (-18°C to 50°C)
Orifice :	4.3 mm
Flow (at 6 bar, ΔP=1bar) :	5.2 W : 0.50C _v , 2.4 W : 0.25C _v , 1.8 W : 0.15C _v
Coil :	General purpose class A, continuous duty, encapsulated
Voltage range :	-15% to +10% of nominal voltage
Power :	5.2 W - 2.4 W - 1.8 W - 1.0 W
Response times :	Energize : 17.0 ms
(with 5.2 W coil)	De-energize : 6.0 ms

- Note : • Valve and coil are not interchangeable.
- Spare parts : • Seal between valve and bar : 16630. • Mounting screw (x2) : 35043. • Blanking plate : M-37001. • End plate kit : M-37003-01
- Options : • Base wire plug-in protector : 16520. • Isolator disc between add-a-units : 28438. • Isolation of inlet and/or exhaust. Special bar. Consult factory. • BSPP Threads.

DIMENSIONS

Number of stations	1	2	3	4	5	6	7	8	9	10
"C" w/regulator	-	53.6	71.6	89.6	107.6	125.6	143.6	161.6	179.6	197.6
"C" w/o regulator	-	51.85	69.85	87.85	105.85	123.85	141.85	159.85	177.85	195.85
"D"	21.7	39.7	57.7	75.7	-	-	-	-	-	-

Dimensions are based on 18 mm centerline spacing
 Note: Bottom & side cylinder ports not available on the same station

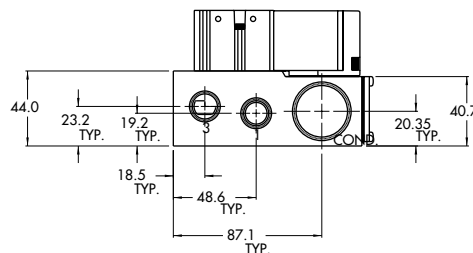
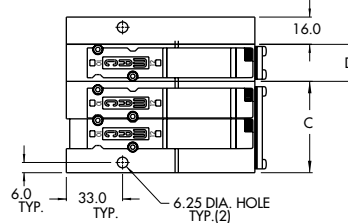
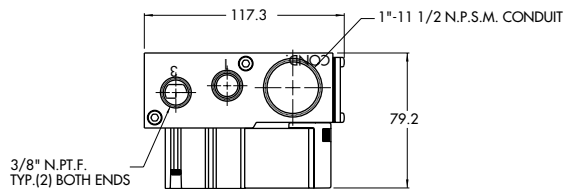
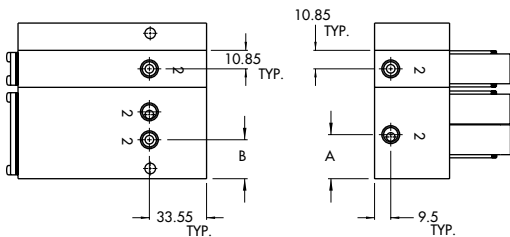

Dim.	1/8"	1/4"	6 mm Legris	1/8" w/regulator	1/4" w/regulator
"A"	22.65	24.20	22.85	-	-
"B"	22.85	22.85	25.85	21.20	22.60

Function	Port size	Flow [Max]	Circuit bar mounting	Profile
3/2 NO-NC	1/8" - 1/4"	0.5C_v	add-on style plug in with Pr. Reg.	44 mm

OPERATIONAL BENEFITS

1. Direct solenoid operated valve.
2. Balanced poppet, immune to variations of pressure.
3. Short stroke with high flow.
4. The patented solenoid develops high shifting forces.
5. Powerful return spring.
6. Manual operator standard on all valves.



HOW TO ORDER

37A-xxx-HxxP-xxx

HOW TO ORDER VALVE FOR CIRCUIT BAR MOUNTING

Port size (see base)	Universal valve	NC only valve
Valve less base	<input type="radio"/> 37A-C1O-HxxP-xxx	<input type="radio"/> 37A-D1O-HxxP-xxx

SOLENOID OPERATOR >

H XX P- X XX*

XX Voltage	X Manual operator	XX Electrical connection
<input type="radio"/> DC 24VDC (1.8 W)	<input type="radio"/> 1 Non-locking	<input type="radio"/> FA Plug-in
<input type="radio"/> DB 24VDC (2.4 W)		<input type="radio"/> FC Plug-in with light
<input type="radio"/> DA 24VDC (5.2 W)		<input type="radio"/> FE Plug-in with suppression diode
<input type="radio"/> AA 120VAC (Mod. No. required see below)		<input type="radio"/> FG Plug-in with suppression diode with LED light
<input type="radio"/> xx Other Options		<input type="radio"/> xx Other Options

HOW TO ORDER "PLUG-IN" CIRCUIT BAR (REGULATORS ORDERED SEPARATELY)**

ECD37A-xxxxx-xxxx

Port size	Spacing mm	Bottom cylinder ports
1/8" NPTF	18	<input type="radio"/> ECD37A-00CEA-A0xx
1/4" NPTF	18	<input type="radio"/> ECD37A-00CEB-A0xx
1/8" NPTF	30	<input type="radio"/> ECD37A-01CEA-C0xx
1/4" NPTF	30	<input type="radio"/> ECD37A-01CEB-C0xx

Number of stations (03=3 stations)

** Other options available, consult factory.
 Note : clic for valves mounted on base at the factory, add - 9 to the model number.
 clic for multi-pin connector (9, 15 or 25).
 for AC voltage use mod. FWR2 after circuit bar model number.
 add-a-unit stations may be added to above bars. Clic here for model numbers.

** Pressure Regulators :

PR37A-GOAx

- X=A (0 to 120 PSI)
- X=B (0 to 80 PSI)
- X=C (0 to 30 PSI)

- A0 = without light
- AA = with light (120V)
- AB = with light (240V)
- AD = with light (24V)
- C0 = terminal strip
- CA = terminal strip with light (120V)
- CB = terminal strip with light (240V)
- CD = terminal strip with light (24V)

**TECHNICAL
DATA**

Fluid :	Compressed air, vacuum, inert gases
Pressure range :	Vacuum to 120 PSI
Lubrication :	Not required, if used select a medium aniline point lubricant (between 180°F and 210°F)
Filtration :	40 µ
Temperature range :	0°F to 120°F (-18°C to 50°C)
Orifice :	4.3 mm
Flow (at 6 bar, ΔP=1bar) :	5.2 W : 0.50C _v , 2.4 W : 0.25C _v , 1.8 W : 0.15C _v
Coil :	General purpose class A, continuous duty, encapsulated
Voltage range :	-15% to +10% of nominal voltage
Power :	5.2 W - 2.4 W - 1.8 W - 1.0 W
Response times :	Energize : 17.0 ms
(with 5.2 W coil)	De-energize : 6.0 ms

- Note : • Valve and coil are not interchangeable.
- Spare parts : • Seal between valve and bar : 16630. • Mounting screw (x2) : 35043. • Blanking plate : M-37001. • End plate kit : M-37003-01
- Options : • Base wire plug-in protector : 16520. • Isolator disc between add-a-units : 28438. • Isolation of inlet and/or exhaust. Special bar. Consult factory. • BSPP Threads.

DIMENSIONS

Number of stations	1	2	3	4	5	6	7	8	9	10
"C" w/regulator	-	53.6	71.6	89.6	107.6	125.6	143.6	161.6	179.6	197.6
"C" w/o regulator	-	51.85	69.85	87.85	105.85	123.85	141.85	159.85	177.85	195.85
"D"	21.7	39.7	57.7	75.7	-	-	-	-	-	-

Dimensions are based on 18 mm centerline spacing
 Note: Bottom & side cylinder ports not available on the same station

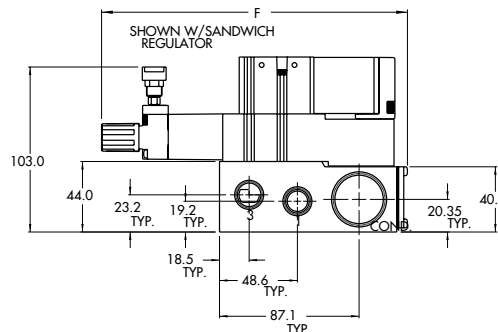
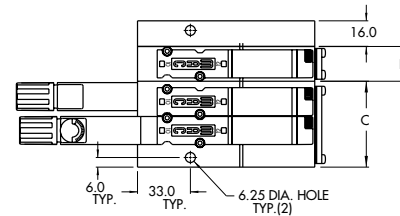
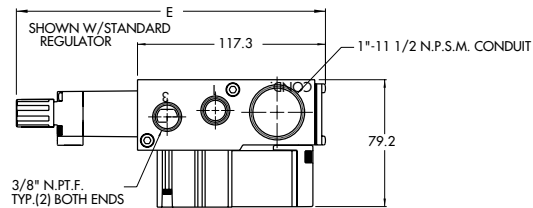
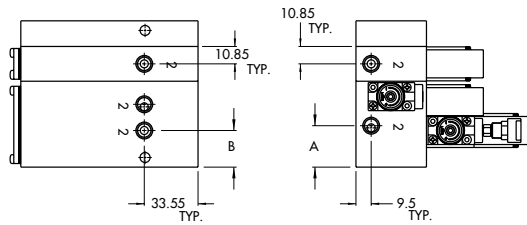

Dim.	1/8"	1/4"	6 mm Legris	1/8" w/regulator	1/4" w/regulator
"A"	22.65	24.20	22.85	-	-
"B"	22.85	22.85	25.85	21.20	22.60

Dim.	Regulator with locking adjusting screw	Regulator with adjusting screw	Regulator with adjusting knob
"E"	188.8	184.7	191.7
"F"	182.5	178.4	185.4

Function	Port size	Flow [Max]	Circuit bar mounting	Profile
3/2 NO-NC	1/8" - 1/4" 6 mm tube receptacle	0.5C_v	plug-in add-a-unit stations	44 mm

OPERATIONAL BENEFITS

1. Direct solenoid operated valve.
2. Balanced poppet, immune to variations of pressure.
3. Short stroke with high flow.
4. The patented solenoid develops high shifting forces.
5. Powerful return spring.
6. Manual operator standard on all valves.



HOW TO ORDER

37A-xxx-HxxP-xxx

HOW TO ORDER VALVE FOR CIRCUIT BAR MOUNTING

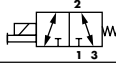
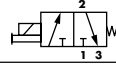
Port size (see base)	Universal valve	NC only valve
		
Valve less base	<input type="radio"/> 37A-C1O-HxxP-xxx	<input type="radio"/> 37A-D1O-HxxP-xxx

SOLENOID OPERATOR >

H XX P- X XX *		
XX Voltage	X Manual operator	XX Electrical connection
<input type="radio"/> DC 24VDC (1.8 W)	<input type="radio"/> 1 Non-locking	<input type="radio"/> FA Plug-in
<input type="radio"/> DB 24VDC (2.4 W)		<input type="radio"/> FC Plug-in with light
<input type="radio"/> DA 24VDC (5.2 W)		<input type="radio"/> FE Plug-in with suppression diode
<input type="radio"/> AA 120VAC (Mod. No. required see below)		<input type="radio"/> FG Plug-in with suppression diode with LED light
<input type="radio"/> xx Other Options		<input type="radio"/> xx Other Options

HOW TO ORDER "PLUG-IN" CIRCUIT BAR**

ECD37A-xxxxx-xxxx

Port size	Spacing mm	Side cylinder ports	Bottom cylinder ports
1/8" NPTF	18	<input type="radio"/> ECD37A-00AFA-A0xx	<input type="radio"/> ECD37A-00BFA-A0xx
1/4" NPTF	18	<input type="radio"/> ECD37A-00AFB-A0xx	<input type="radio"/> ECD37A-00BFB-A0xx
6 mm tube receptacle	18	<input type="radio"/> ECD37A-00AFG-A0xx	<input type="radio"/> ECD37A-00BFG-A0xx
1/8" NPTF	30	<input type="radio"/> ECD37A-01AFA-C0xx	<input type="radio"/> ECD37A-01BFA-C0xx
1/4" NPTF	30	<input type="radio"/> ECD37A-01AFB-C0xx	<input type="radio"/> ECD37A-01BFB-C0xx
6 mm tube receptacle	30	<input type="radio"/> ECD37A-01AFG-C0xx	<input type="radio"/> ECD37A-01BFG-C0xx

Number of stations (03=3 stations) - maximum length is 4 stations.

** Other options available, consult factory.

Note : clic for valves mounted on base at the factory, add - 9 to the model number.
for AC voltage use mod. FWR2 after circuit bar model number.
when add-a-unit stations are added to bars with a multi-pin connector, mod SD03 should be included with add-a-unit model number.

- A0 = without light
- AA = with light (120V)
- AB = with light (240V)
- AD = with light (24V)
- C0 = terminal strip
- CA = terminal strip with light (120V)
- CB = terminal strip with light (240V)
- CD = terminal strip with light (24V)

**TECHNICAL
DATA**

Fluid :	Compressed air, vacuum, inert gases
Pressure range :	Vacuum to 120 PSI
Lubrication :	Not required, if used select a medium aniline point lubricant (between 180°F and 210°F)
Filtration :	40 µ
Temperature range :	0°F to 120°F (-18°C to 50°C)
Orifice :	4.3 mm
Flow (at 6 bar, ΔP=1bar) :	5.2 W : 0.50C _v , 2.4 W : 0.25C _v , 1.8 W : 0.15C _v
Coil :	General purpose class A, continuous duty, encapsulated
Voltage range :	-15% to +10% of nominal voltage
Power :	5.2 W - 2.4 W - 1.8 W - 1.0 W
Response times :	Energize : 17.0 ms
(with 5.2 W coil)	De-energize : 6.0 ms

- Note : • Valve and coil are not interchangeable.
- Spare parts : • Seal between valve and bar : 16630. • Mounting screw (x2) : 35043. • Blanking plate : M-37001.
• O-ring port seal (x2) : 17015-01 • Tie rod (x2) : 79007-01 (one station length).
- Options : • Isolation of inlet and/or exhaust. Special bar. Consult factory. • BSPP Threads.

DIMENSIONS

Number of stations	1	2	3	4	5	6	7	8	9	10
"C" w/regulator	-	53.6	71.6	89.6	107.6	125.6	143.6	161.6	179.6	197.6
"C" w/o regulator	-	51.85	69.85	87.85	105.85	123.85	141.85	159.85	177.85	195.85
"D"	21.7	39.7	57.7	75.7	-	-	-	-	-	-

Dimensions are based on 18 mm centerline spacing
Note: Bottom & side cylinder ports not available on the same station

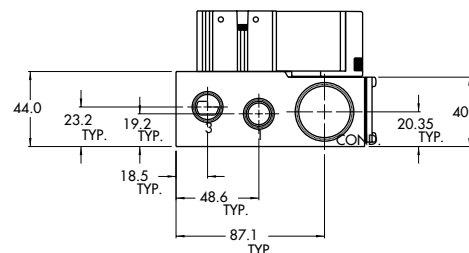
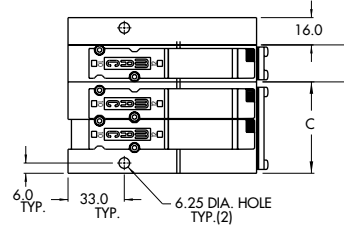
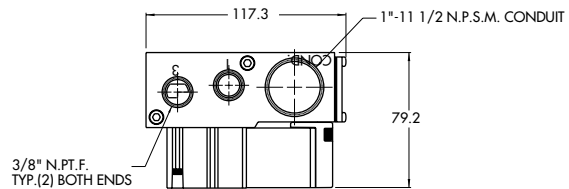
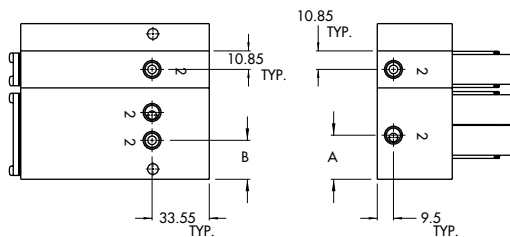

Dim.	1/8"	1/4"	6 mm Legris	1/8" w/regulator	1/4" w/regulator
"A"	22.65	24.20	22.85	-	-
"B"	22.85	22.85	25.85	21.20	22.60

Function	Port size	Flow [Max]	Circuit bar mounting	Profile
3/2 NO-NC	1/8" - 1/4"	0.5C_v	plug-in add-a-unit stations with Pr. Reg.	44 mm

OPERATIONAL BENEFITS

1. Direct solenoid operated valve.
2. Balanced poppet, immune to variations of pressure.
3. Short stroke with high flow.
4. The patented solenoid develops high shifting forces.
5. Powerful return spring.
6. Manual operator standard on all valves.



HOW TO ORDER

37A-xxx-HxxP-xxx

HOW TO ORDER VALVE FOR CIRCUIT BAR MOUNTING

Port size (see base)	Universal valve	NC only valve
Valve less base	<input type="radio"/> 37A-C1O-HxxP-xxx	<input type="radio"/> 37A-D1O-HxxP-xxx

SOLENOID OPERATOR >

H XX P- X XX*

XX Voltage	X Manual operator	XX Electrical connection
<input type="radio"/> DC 24VDC (1.8 W)	<input type="radio"/> 1 Non-locking	<input type="radio"/> FA Plug-in
<input type="radio"/> DB 24VDC (2.4 W)		<input type="radio"/> FC Plug-in with light
<input type="radio"/> DA 24VDC (5.2 W)		<input type="radio"/> FE Plug-in with suppression diode
<input type="radio"/> AA 120VAC (Mod. No. required see below)		<input type="radio"/> FG Plug-in with suppression diode with LED light
<input type="radio"/> xx Other Options		<input type="radio"/> xx Other Options

HOW TO ORDER "PLUG-IN" CIRCUIT BAR (REGULATORS ORDERED SEPARATELY)**

ECD37A-xxxxxx-xxxx

Port size	Spacing mm	Bottom cylinder ports
1/8" NPTF	18	<input type="radio"/> ECD37A-00CFA-A0xx
1/4" NPTF	18	<input type="radio"/> ECD37A-00CFB-A0xx
1/8" NPTF	30	<input type="radio"/> ECD37A-01CFA-C0xx
1/4" NPTF	30	<input type="radio"/> ECD37A-01CFB-C0xx

Number of stations (03=3 stations) - maximum length is 4 stations.

** Other options available, consult factory.

Note : clic for valves mounted on base at the factory, add - 9 to the model number.
for AC voltage use mod. FWR2 after circuit bar model number.
when add-a-unit stations are added to bars with a multi-pin connector, mod SD03 should be included with add-a-unit model number.

** Pressure Regulators :

PR37A-GOAx

- X=A (0 to 120 PSI)
- X=B (0 to 80 PSI)
- X=C (0 to 30 PSI)

- A0 = without light
- AA = with light (120V)
- AB = with light (240V)
- AD = with light (24V)
- C0 = terminal strip
- CA = terminal strip with light (120V)
- CB = terminal strip with light (240V)
- CD = terminal strip with light (24V)

**TECHNICAL
DATA**

Fluid :	Compressed air, vacuum, inert gases
Pressure range :	Vacuum to 120 PSI
Lubrication :	Not required, if used select a medium aniline point lubricant (between 180°F and 210°F)
Filtration :	40 µ
Temperature range :	0°F to 120°F (-18°C to 50°C)
Orifice :	4.3 mm
Flow (at 6 bar, ΔP=1bar) :	5.2 W : 0.50C _v , 2.4 W : 0.25C _v , 1.8 W : 0.15C _v
Coil :	General purpose class A, continuous duty, encapsulated
Voltage range :	-15% to +10% of nominal voltage
Power :	5.2 W - 2.4 W - 1.8 W - 1.0 W
Response times :	Energize : 17.0 ms
(with 5.2 W coil)	De-energize : 6.0 ms

Note : • Valve and coil are not interchangeable.

Spare parts : • Seal between valve and bar : 16630. • Mounting screw (x2) : 35043. • Blanking plate : M-37001.
• O-ring port seal (x2) : 17015-01 • Tie rod (x2) : 79007-01 (one station length). • Regulator blanking plate : R-47003.

Options : • Isolation of inlet and/or exhaust. Special bar. Consult factory. • BSPP Threads.

DIMENSIONS

Number of stations	1	2	3	4	5	6	7	8	9	10
"C" w/regulator	-	53.6	71.6	89.6	107.6	125.6	143.6	161.6	179.6	197.6
"C" w/o regulator	-	51.85	69.85	87.85	105.85	123.85	141.85	159.85	177.85	195.85
"D"	21.7	39.7	57.7	75.7	-	-	-	-	-	-

Dimensions are based on 18 mm centerline spacing
Note: Bottom & side cylinder ports not available on the same station

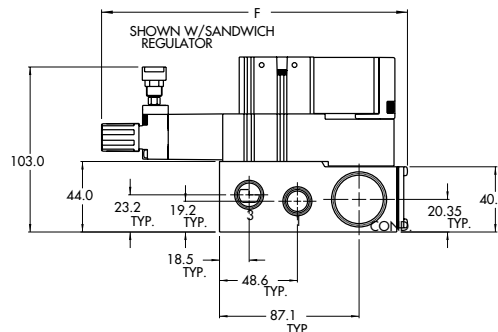
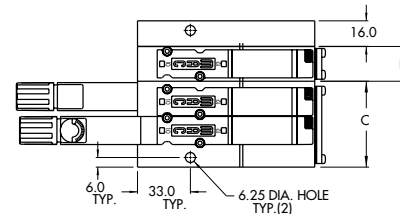
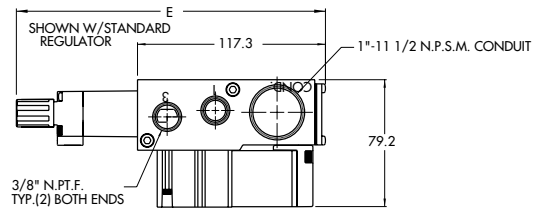
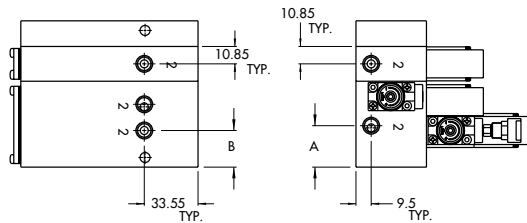

Dim.	1/8"	1/4"	6 mm Legris	1/8" w/regulator	1/4" w/regulator
"A"	22.65	24.20	22.85	-	-
"B"	22.85	22.85	25.85	21.20	22.60

Dim.	Regulator with locking adjusting screw	Regulator with adjusting screw	Regulator with adjusting knob
"E"	188.8	184.7	191.7
"F"	182.5	178.4	185.4



Section 2

Options

Codification table for voltages / Wire length / Manual operators / Electrical connections

VALVE CODE ►

-HXX X - X XX
1 2 3 4

OPTIONS AVAILABLE FOR

- Solenoid valves 37 & 47 Series

1. VOLTAGE

- H XX	X - X XX	VOLTAGE
DC Options		
<input type="radio"/>	DA	24 VDC (5.2 W)
<input type="radio"/>	DB	24 VDC (2.4 W)
<input type="radio"/>	DC	24 VDC (1.8 W)
<input type="radio"/>	DD	24 VDC (1.0 W)
<input type="radio"/>	DF	12 VDC (5.2 W)
<input type="radio"/>	DG	12 VDC (2.4 W)
<input type="radio"/>	DH	12 VDC (1.8 W)
<input type="radio"/>	DJ	12 VDC (1.0 W)
<input type="radio"/>	DL	120 VDC (6.3 W)
AC Options (50/60hz)		
<input type="radio"/>	AA	120 VAC (6.7 W)
<input type="radio"/>	AB	220 VAC (5.6 W)
<input type="radio"/>	AC	240 VAC (5.8 W)
<input type="radio"/>	AD	24 VAC (7.8 W)

Note : AC Voltages only available with "H" & "F" type connectors. MOD FWR2 must be used with the "F" type connectors.

2. WIRE LENGTH

- H XX	X - X XX	WIRE LENGTH
<input type="radio"/>	O	No lead wire
<input type="radio"/>	A	18"
<input type="radio"/>	B	24"
<input type="radio"/>	C	36"
<input type="radio"/>	D	48"
<input type="radio"/>	E	72"
<input type="radio"/>	F	96"
<input type="radio"/>	G	120"
<input type="radio"/>	H	144"
<input type="radio"/>	P	Plug-in (used only with "F" type connector Opts.)

Use "O" with MJ & MM Opts.

3. MANUAL OPERATOR

- H XX	X - X XX	MANUAL OPERATOR
<input type="radio"/>	0	No operator
<input type="radio"/>	1	Non-locking recessed
<input type="radio"/>	2	Locking recessed
<input type="radio"/>	3	Non-locking extended
<input type="radio"/>	4	Locking extended



4. ELECTRICAL CONNECTION

- H XX	X - X XX	ELECTRICAL CONNECTION
<input type="radio"/>	BA	Flying leads
<input type="radio"/>	BB	Flying leads with ground wire
<input type="radio"/>	BC	Flying leads with led light
<input type="radio"/>	BD	Flying leads with led light & ground wire
<input type="radio"/>	BE	Flying leads with suppression diode
<input type="radio"/>	BF	Flying leads with suppression diode & ground wire
<input type="radio"/>	BG	Flying leads with suppression diode plus led light
<input type="radio"/>	BH	Flying leads with suppression diode plus led light & ground wire
<input type="radio"/>	*BN	Flying leads with suppression diode plus blocking diode
<input type="radio"/>	*BP	Flying leads with suppression diode plus blocking diode & ground wire
<input type="radio"/>	*BR	Flying leads with suppression diode plus blocking diode & led light
<input type="radio"/>	*BS	Flying leads with suppression diode plus blocking diode & led light & ground wire
<input type="radio"/>	FA	Plug-in
<input type="radio"/>	FB	Plug-in with ground wire
<input type="radio"/>	FC	Plug-in with led light
<input type="radio"/>	FD	Plug-in with led light & ground wire
<input type="radio"/>	FE	Plug-in with suppression diode
<input type="radio"/>	FF	Plug-in with suppression diode & ground wire
<input type="radio"/>	FG	Plug-in with suppression diode plus led light
<input type="radio"/>	FH	Plug-in with suppression diode plus led light & ground wire
		Note : FA ---- FH options for use with ECD type circuit bars
<input type="radio"/>	HA	Circuit board plug-in with full wave rectifier & led light
<input type="radio"/>	HB	Circuit board with full wave rectifier & led with ground wire
<input type="radio"/>	HC	Same as "HA" without lead wires
<input type="radio"/>	HD	Same as "HB" without lead wires
<input type="radio"/>	HL	Circuit board plug-in with suppression diode plus blocking diode & led light
<input type="radio"/>	HN	Same as "HL" without lead wires
<input type="radio"/>	MA	Plug-in wire assembly
<input type="radio"/>	MB	Plug-in wire assembly with ground wire
<input type="radio"/>	MC	Plug-in wire assembly with led light
<input type="radio"/>	MD	Plug-in wire assembly led light & ground wire
<input type="radio"/>	ME	Plug-in wire assembly with suppression diode
<input type="radio"/>	MF	Plug-in wire assembly with suppression diode & ground wire
<input type="radio"/>	*MG	Plug-in wire assembly suppression diode plus led light
<input type="radio"/>	*MH	Plug-in wire assembly suppression diode plus led light & ground wire
<input type="radio"/>	*MN	Plug-in wire assembly with suppression diode plus blocking diode
<input type="radio"/>	*MP	Plug-in wire assembly with suppression diode plus blocking diode & ground wire
<input type="radio"/>	MR	Plug-in wire assembly with suppression diode plus blocking diode & led light
<input type="radio"/>	MS	Plug-in wire assembly with suppression diode plus blocking diode & led light & ground wire
<input type="radio"/>	MJ	Plug-in housing w/o wire assembly ("MA" option without wire assembly)
<input type="radio"/>	MM	Plug-in housing w/o wire assembly ("MB" option without wire assembly)

* Blocking diode is in lead wire.

MOD. S009

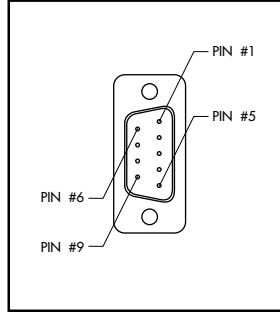

TECHNICAL DATA

- Type «SUB_D»
- Number of contacts : 9
- Solder termination (Dia. 0.6 mm/0.14 mm²/26-22 AWG)
- Operating current 5 A/contact
- Rated voltage 125 V~
- Temp. range -40° to +125°C
- Insulation resistance ≥ 5.0⁹ Ω
- Protection class IP40 (DIN 40050)
- Number of solenoids : 7 max.
- Max. 24 V=/5.4 W per solenoid
- 2 common wires

MOD. S015

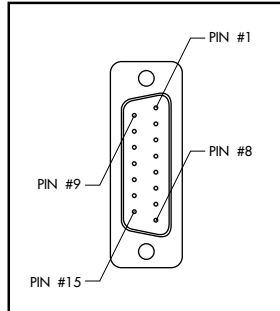

TECHNICAL DATA

- Type «SUB_D»
- Number of contacts : 15
- Solder termination (Dia. 0.6 mm/0.14 mm²/26-22 AWG)
- Operating current 5 A/contact
- Rated voltage 125 V~
- Temp. range -40° to +125°C
- Insulation resistance ≥ 5.0⁹ Ω
- Protection class IP40 (DIN 40050)
- Number of solenoids : 12 max.
- Max. 24 V=/5.4 W per solenoid
- 3 common wires

MOD. S025

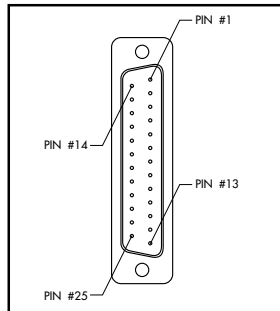

TECHNICAL DATA

- Type «SUB_D»
- Number of contacts : 25
- Solder termination (Dia. 0.6 mm/0.14 mm²/26-22 AWG)
- Operating current 5 A/contact
- Rated voltage 125 V~
- Temp. range -40° to +125°C
- Insulation resistance ≥ 5.0⁹ Ω
- Protection class IP40 (DIN 40050)
- Number of solenoids : 20 max.
- Max. 24 V=/5.4 W per solenoid
- 5 common wires

Note : Use desired MOD. number after circuit bar part number

Connector termination details

